

INSTALLATION INSTRUCTIONS
for MOMENTARY - CABLE/ROPE OPERATED SWITCHES

04963 - 251 through 04963 - 499 | 94963 - 251 through 94963 - 499

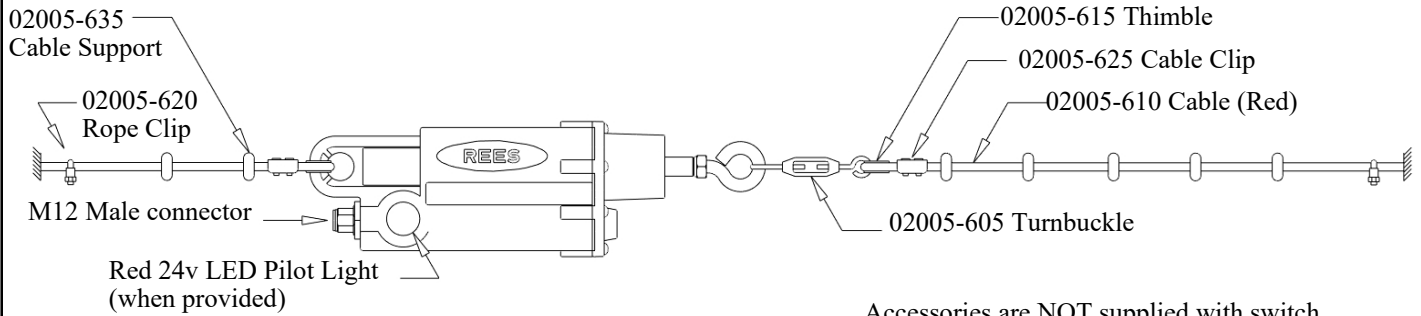

Right Facing Switch shown above.

Accessories are NOT supplied with switch
NOR are they required for all installations.

Since every installation is unique and separate, the following instructions can be considered flexible. There are some basic switch setup procedures that must be observed and they are indicated by the symbol (➤). The balance of the suggestions and information is subject to change to accommodate those most familiar and responsible for the installation.

INSTALLATION:

- Observe all SAFETY REQUIREMENTS and PROCEDURES during installation, set-up and running.
- N.E.C. and local wiring codes MUST be followed at all times.
- The first cable support SHOULD be located 6 to 12 in. (15 to 30 cm) from the switch. (see drawing on other side)
- The first cable support SHOULD be located so that the cable is aligned with the switch shaft within 5 degrees.
- It is recommended that the balance of the cable supports be spaced at intervals NOT exceeding 10 feet (~3m). Supports at properly spaced intervals are necessary to ensure that the cable weight will NOT affect switch operation.
- The maximum recommended cable length is 33 feet (10 m) in each direction and SHOULD be in as straight of a line as possible.
- Wiring SHOULD be through the motor control circuit.
(See reference simplified diagram below, and model specific wiring information)

MAINTENANCE:

- Regular Preventive Maintenance inspections are recommended.
- Some conditions to watch for are:
 - Proper slack/swale of the pull cable.
 - Physical damage to the device.
 - Physical damage to the cable.
 - Frayed wiring cordset.
 - Loose cable connections.
 - Any loose components.
 - Any worn components.
- If other assistance is desired please contact the factory.

Warning—Danger

These products should only be used where point-of operation guarding devices have been properly installed and maintained so that all appropriate OSHA and ANSI regulations and standards are met. Misapplication of these products on machinery lacking effective point-of-operation safeguards can cause serious injury to the operator of that machinery.

AVERTISSEMENT - DANGER

Ces produit doivent seulement être utilisés sur des postes à risque correctement sécurisés et entretenus afin d'être conforme aux standards et réglementations en vigueur (CSA, CLC). Un mauvais usage de ces produits sur des machines et des postes de travail non sécurisés de manière efficace peut causer des blessures graves au technicien maniant ces machines.

SIMPLIFIED CONTROL CIRCUIT

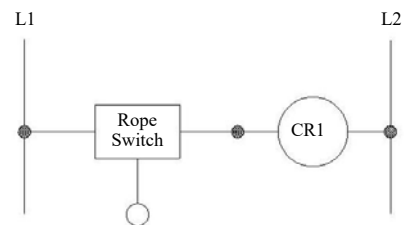

All wiring/components provided by user.

OPERATING SPECIFICATIONS
for MOMENTARY - CABLE/ROPE OPERATED SWITCHES

04963 - 251 through 04963 - 499 94963 - 251 through 94963 - 499

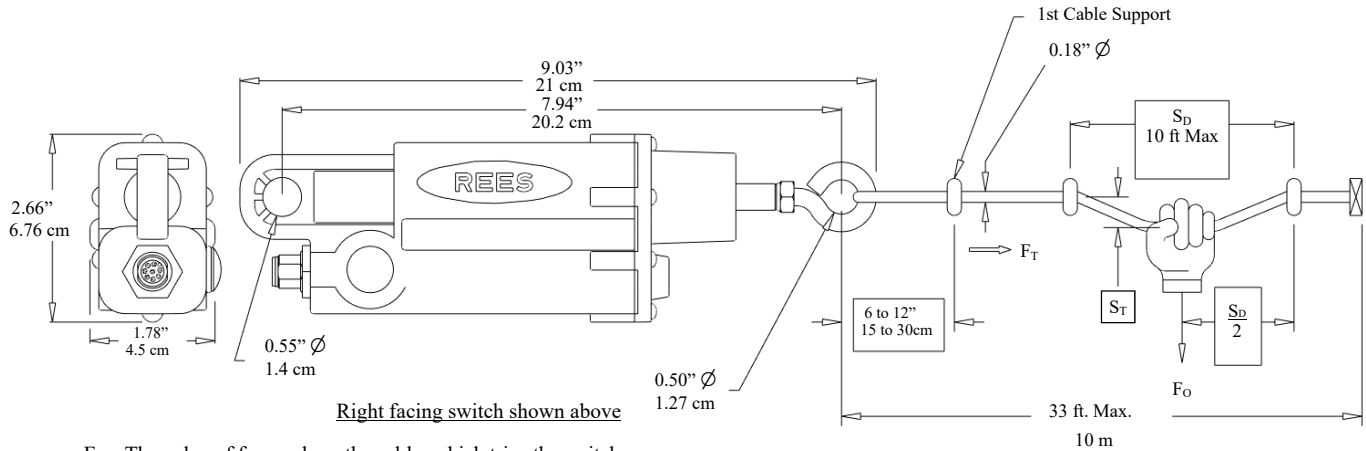

F_T = The value of force, along the cable, which trips the switch.

F_O = The value of force, applied by the operator perpendicular to the cable, which trips the switch.

S_D = The distance between the cable supports.

S_T = The distance the cable is deflected at the time of tripping.. * S_T is in addition to any slack "droop" req'd for set-up.

Connector	Pilot Light	Rating	F_T Trip Force	$S_D = 5 \text{ ft. / 1.5 m}$		$S_D = 10 \text{ ft. / 3.0 m}$	
				F_O	S_T	F_O	S_T
5 Pin M12 Male A-Code	No	60V	10 lb. 4.5 kg	1.8 lb. 0.8 kg	3 in.* 7.6 cm	1.2 lb. 0.5 kg	4 in.* 10.2 cm
	Yes	24V					
8 Pin M12 Male A-Code	No	30V	10 lb. 4.5 kg	1.8 lb. 0.8 kg	3 in.* 7.6 cm	1.2 lb. 0.5 kg	4 in.* 10.2 cm
	Yes	24V					

Warning - Danger

These products should only be used where point-of-operation guarding devices have been properly installed and maintained so that all appropriate OSHA and ANSI regulations and standards are met. Misapplication of these products on machinery lacking effective point-of-operation safeguards can cause serious injury to the operator of that machinery.

AVERTISSEMENT - DANGER

Ces produit doivent seulement être utilisés sur des postes à risque correctement sécurisés et entretenus afin d'être conforme aux standards et réglementations en vigueur (CSA, CLC). Un mauvais usage de ces produits sur des machines et des postes de travail non sécurisés de manière efficace peut causer des blessures graves au technicien maniant ces machines.

UL listed (File E58589); **NKCR** (E58589) **C-UL-US**;

Switches comply with UL-508; CSA-C 22.2 No. 14; EN 60947-5-1: 2017;

04963 versions: Type 4; 94963 versions: Type 4X







Temperature: Operating = 0°C to +55°C (+32°F to +131°F);

Storage = -40°C to +85°C (-40°F to +185°F)

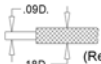
Mechanical Life Rating = 250,000 operations;

Operating Position: Can be mounted in any position.

AVAILABLE ACCESSORIES:

02005-605 Turnbuckle Tension Adj. 	02005-610 Cable, Steel  (Red Vinyl)	02005-615 Thimble, Strain Relief 	02005-620 Rope Clip Standard 	02005-840 Cable/ Handle Assembly 
02005-625 Cable Clip Optional 	02005-630 Spring, Tension 	02005-635 Eye Bolt Cable Support 	02005-205/-208 Mating M12 Cordset 2m - 5 or 8 pin 